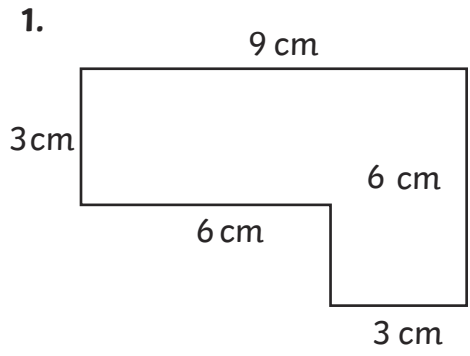
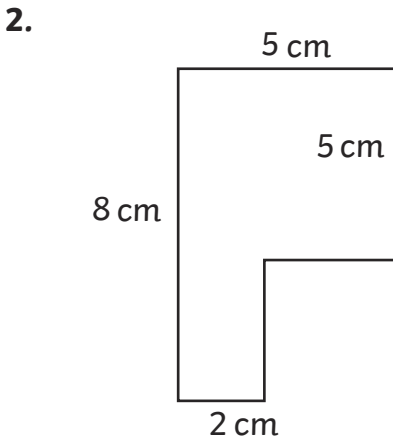

# Calculate the Perimeter of Composite Rectilinear Shapes

I can calculate the perimeter of simple composite rectilinear shapes.

Add the length of each side to find the perimeter of each shape. Not to Scale.

- 

1.   
9 cm   
3 cm   
6 cm   
6 cm   
3 cm
- 

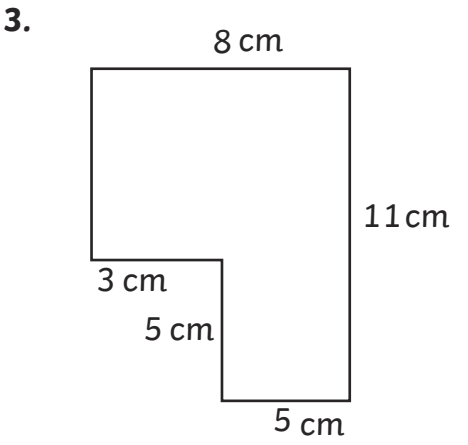
2.   
5 cm   
8 cm   
2 cm   
5 cm
- 

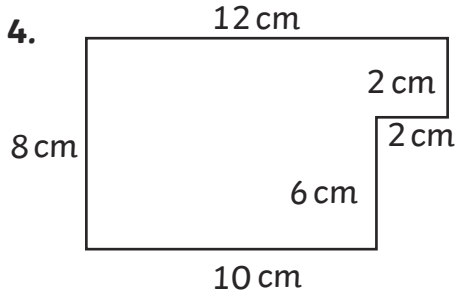
3.   
8 cm   
3 cm   
5 cm   
5 cm   
11 cm
- 

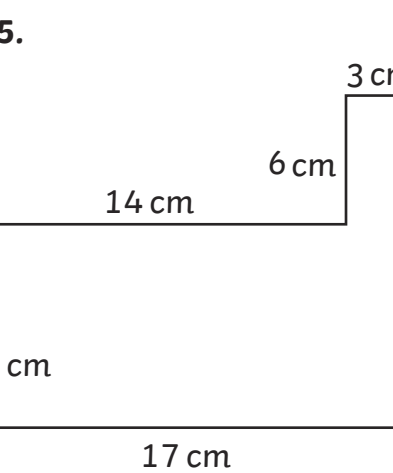
4.   
12 cm   
8 cm   
10 cm   
6 cm   
2 cm
- 

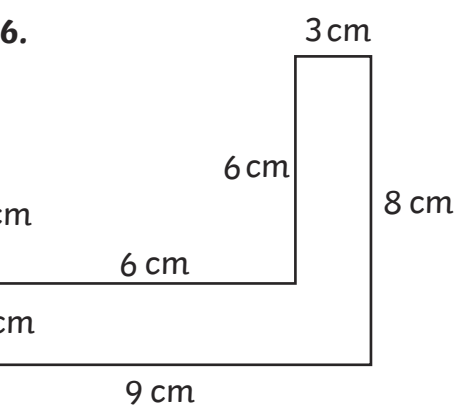
5.   
14 cm   
5 cm   
17 cm   
6 cm   
3 cm
- 

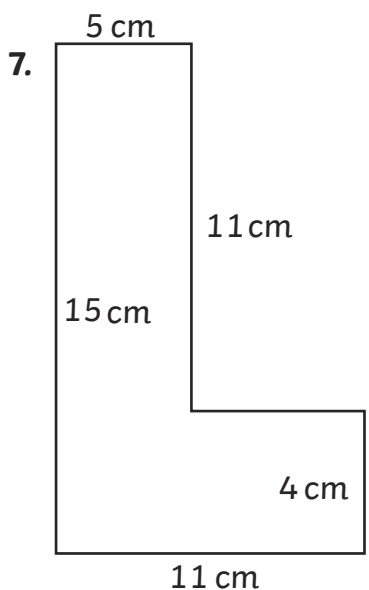
6.   
3 cm   
11 cm   
9 cm   
6 cm   
8 cm
- 

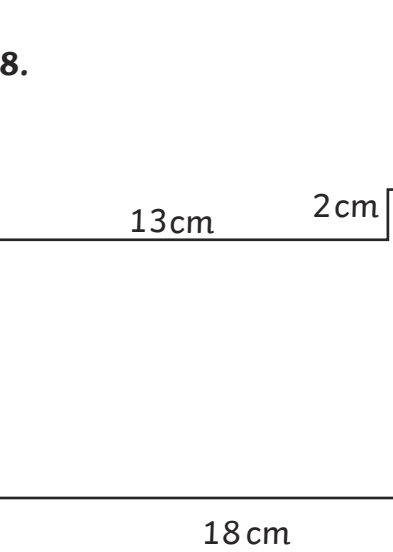
7.   
5 cm   
15 cm   
11 cm   
11 cm   
4 cm
- 

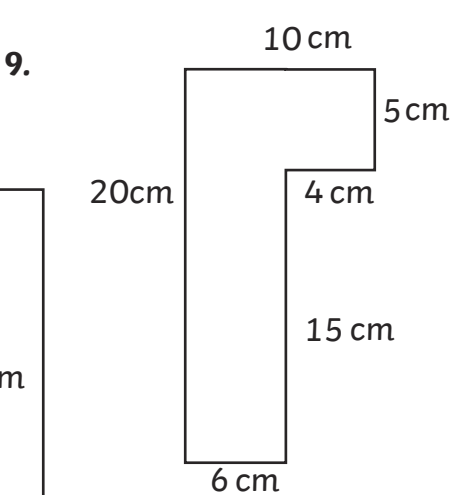
8.   
13 cm   
6 cm   
18 cm   
2 cm   
5 cm
- 

9.   
10 cm   
20 cm   
6 cm   
4 cm   
15 cm

# Calculate the Perimeter of Composite Rectilinear Shapes

Use this grid to draw four composite rectilinear shapes, not to scale, with a perimeter of 40cm.

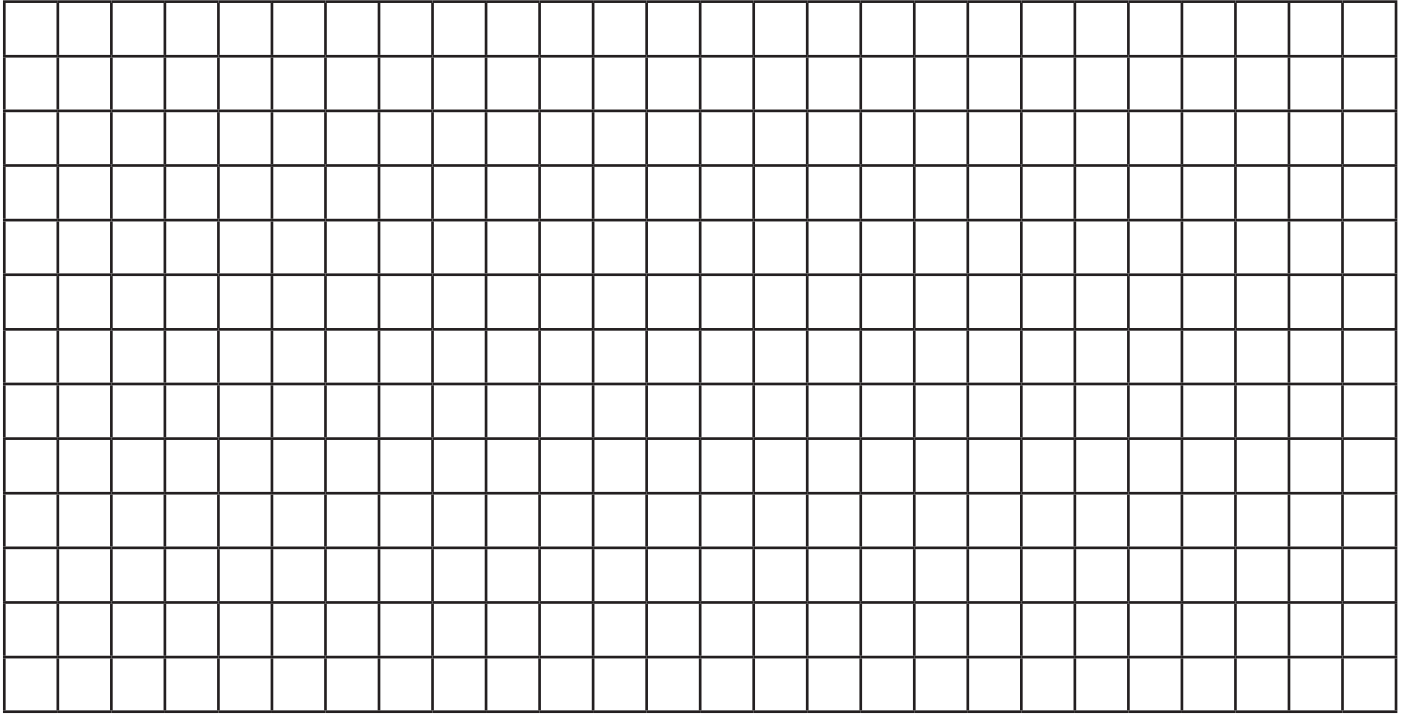

Use this grid to draw four composite rectilinear shapes, not to scale, with a perimeter of 60cm.

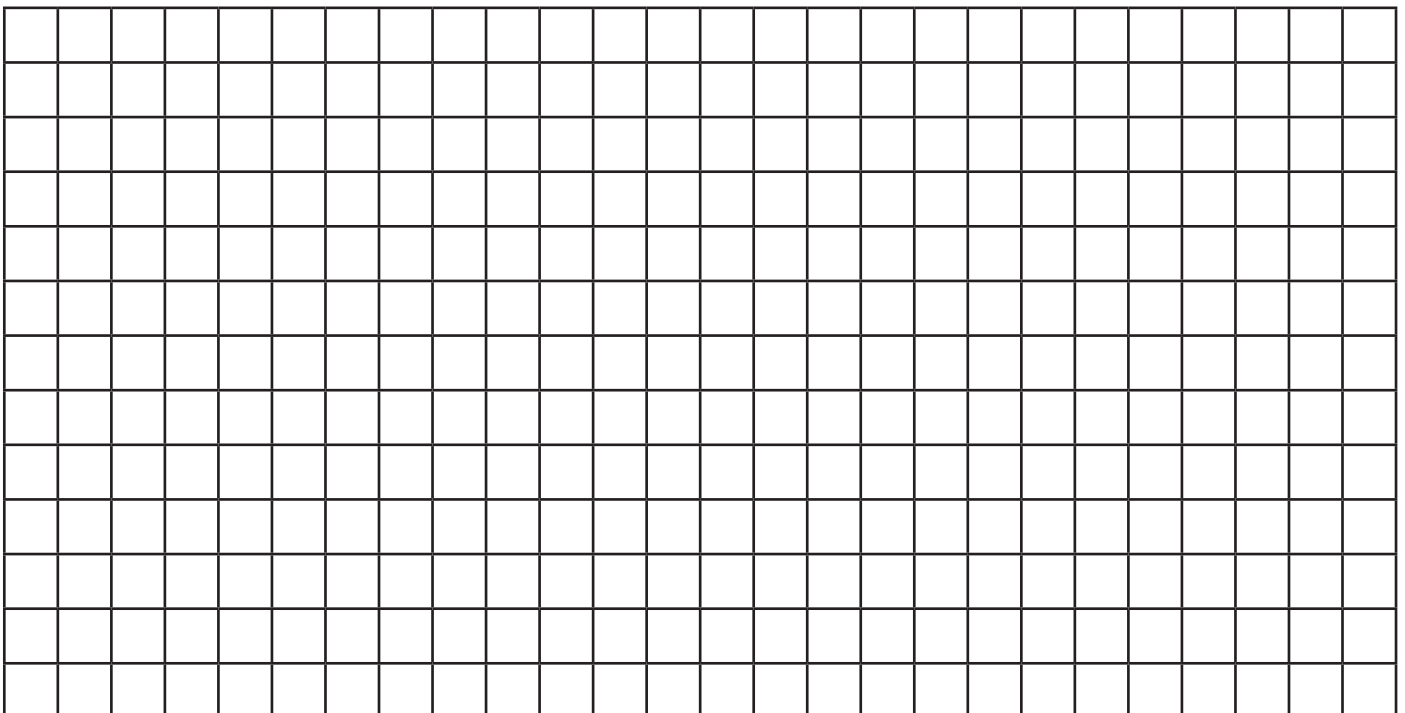

# Calculate the Perimeter of Composite Rectilinear Shapes

I can calculate the perimeter of simple composite rectilinear shapes.

Add the length of each side to find the perimeter of each shape. Not to Scale.

1.

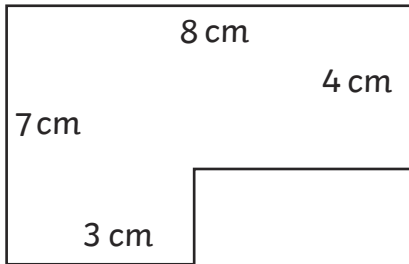

2.

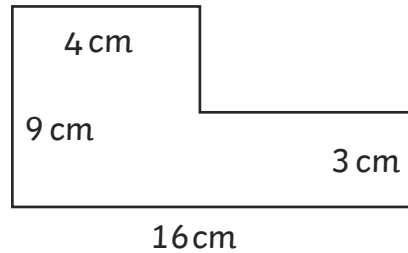

3.

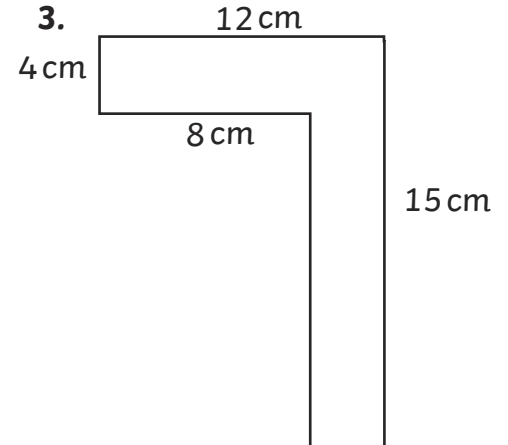

4.

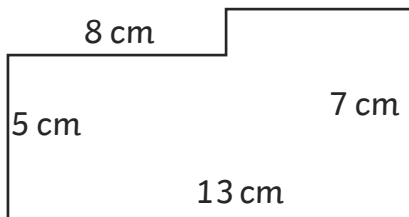

5.

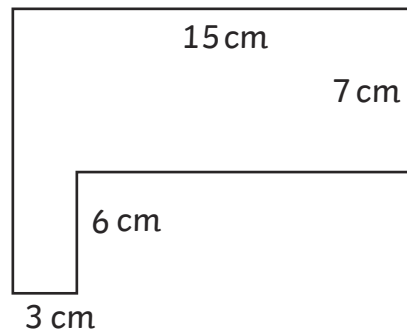

6.

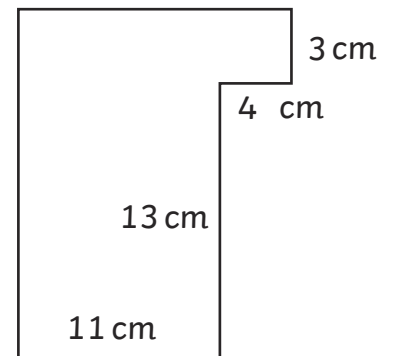

7.

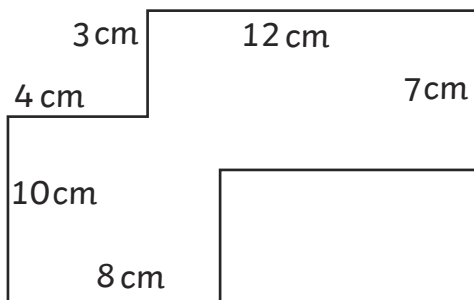

8.

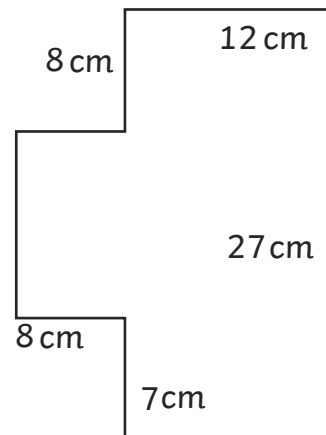

9.

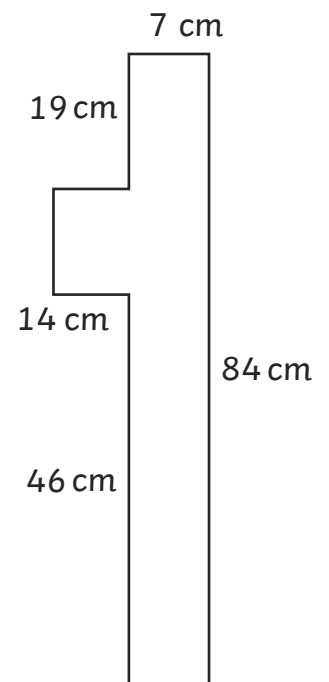

# Calculate the Perimeter of Composite Rectilinear Shapes

Draw four composite rectilinear shapes, not to scale, with a perimeter of 46cm.

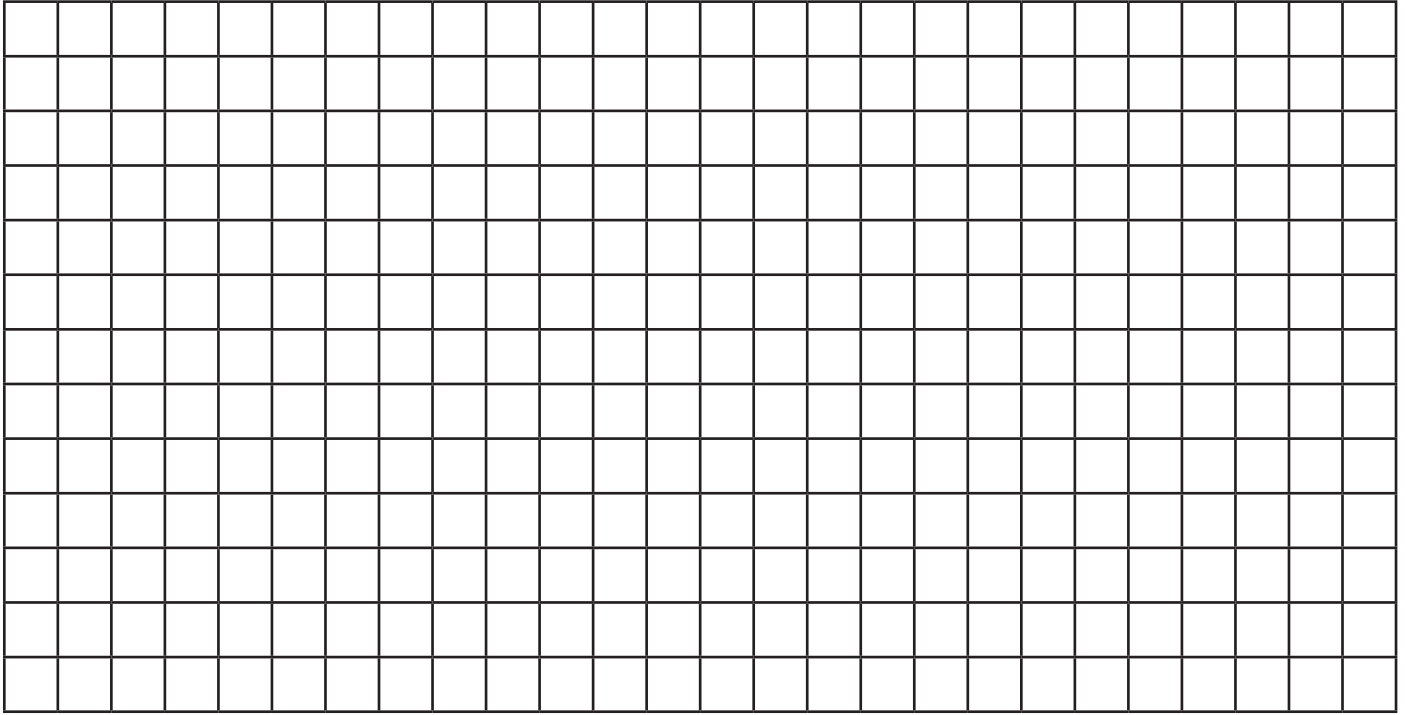

Draw four composite rectilinear shapes, not to scale, with a perimeter of 72cm.

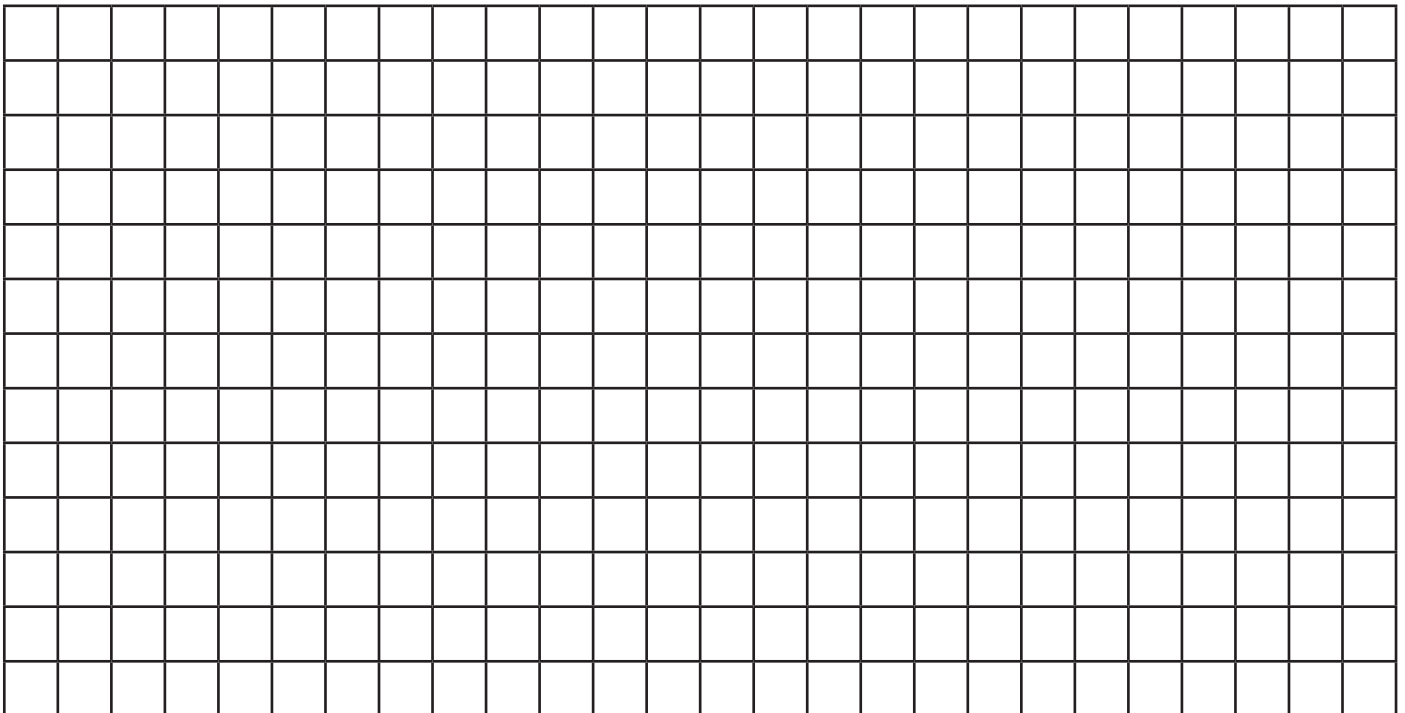

# Calculate the Perimeter of Composite Rectilinear Shapes

I can measure the perimeter of simple composite rectilinear shapes.

Measure the length of each side of the shapes and add to find the perimeter.

1.

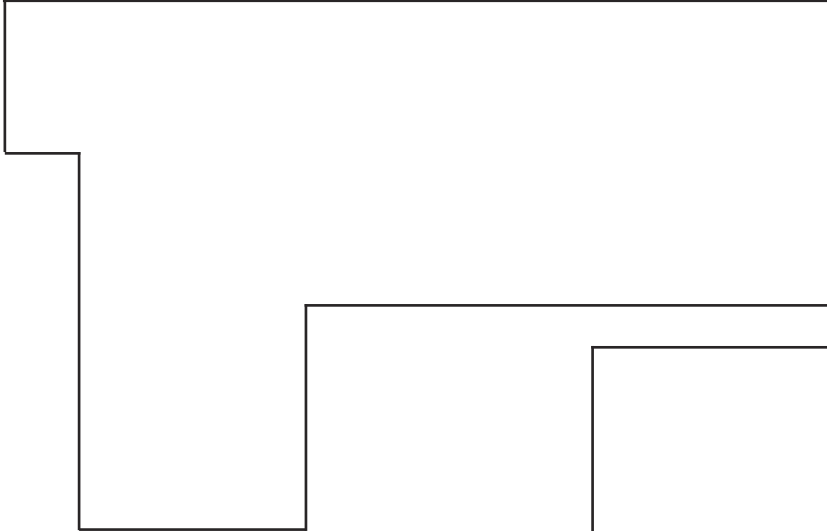

2.

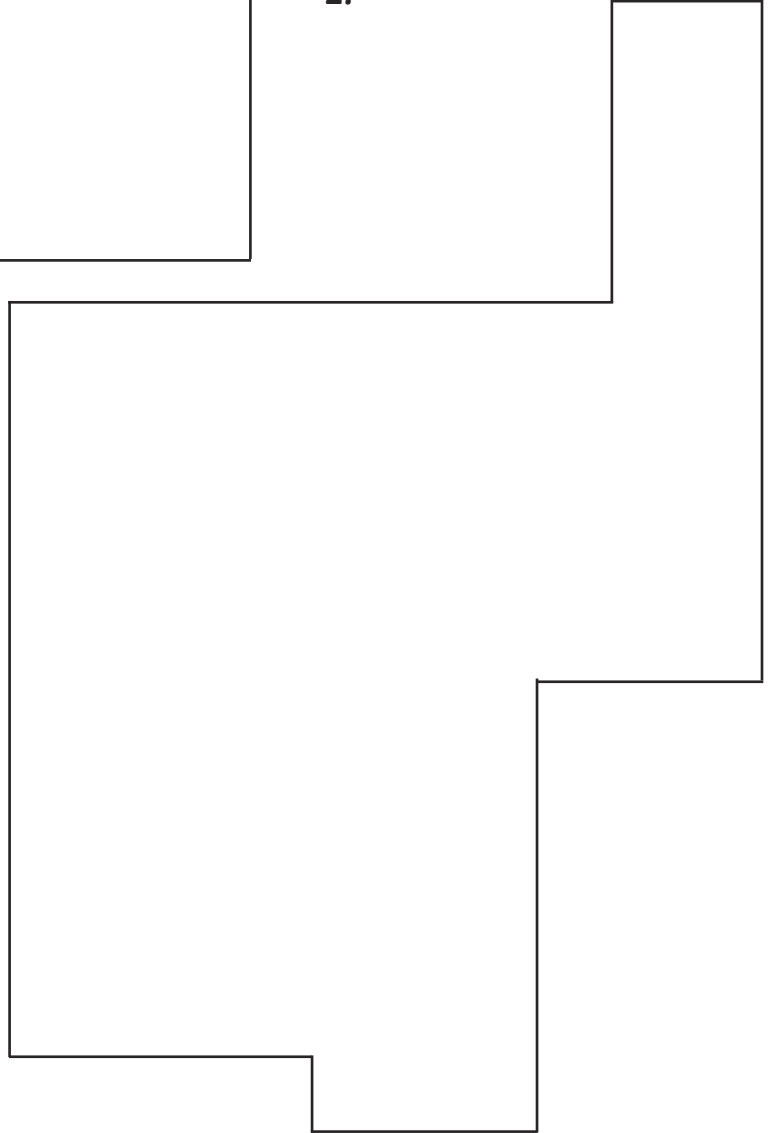

# Calculate the Perimeter of Composite Rectilinear Shapes

3.

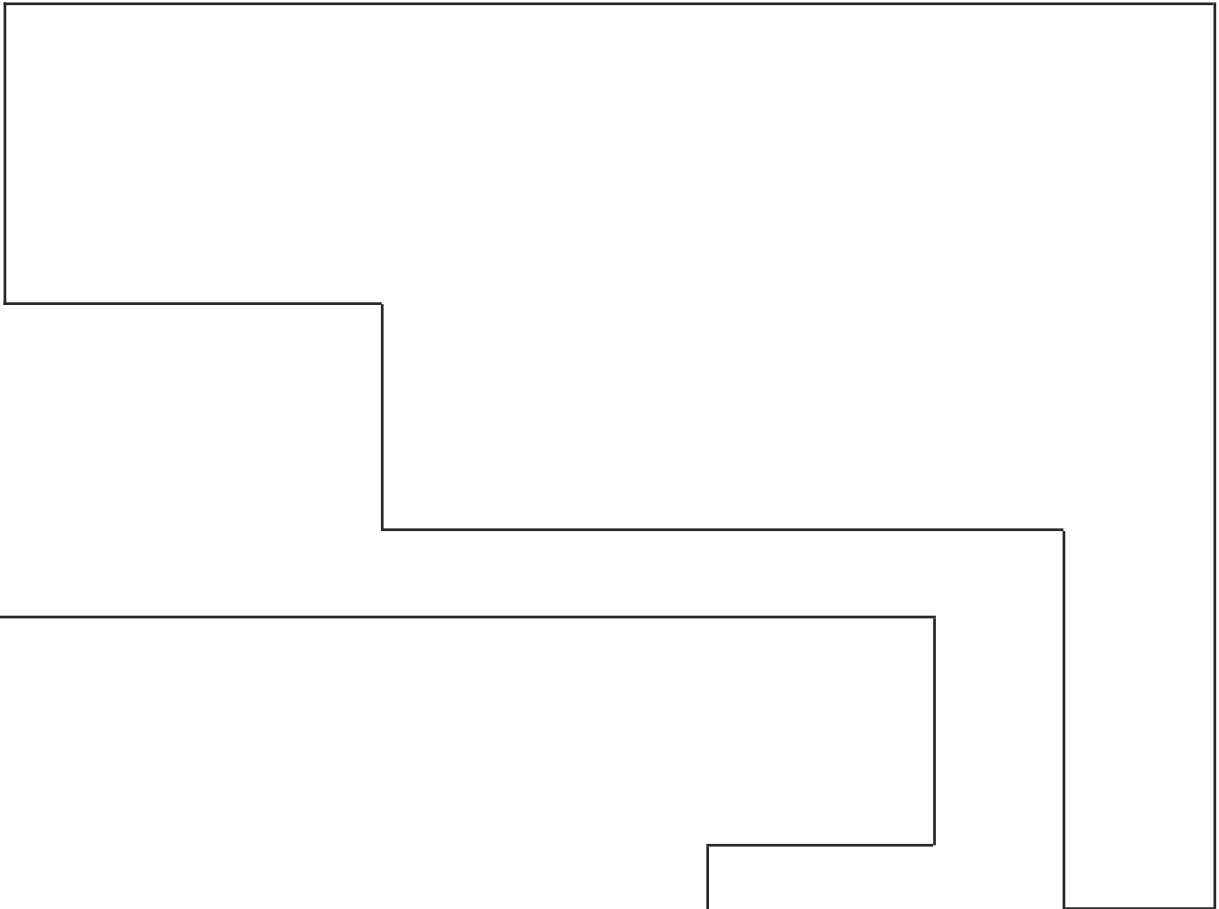

4.

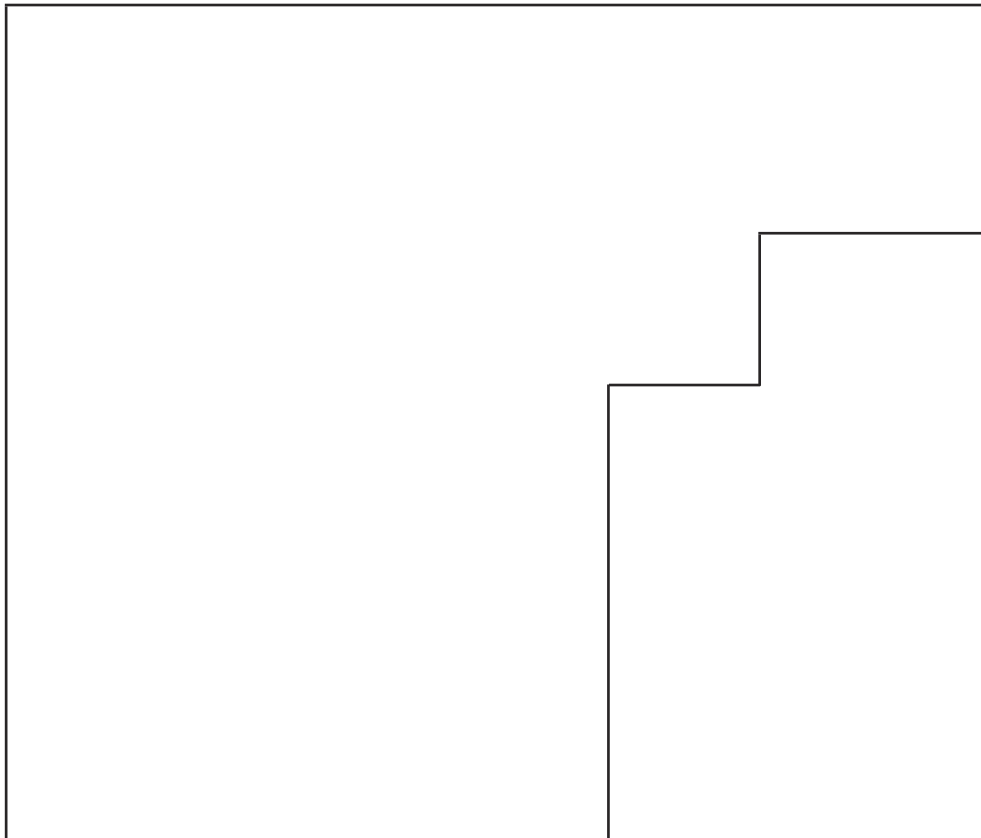

# Calculate the Perimeter of Composite Rectilinear Shapes

5.

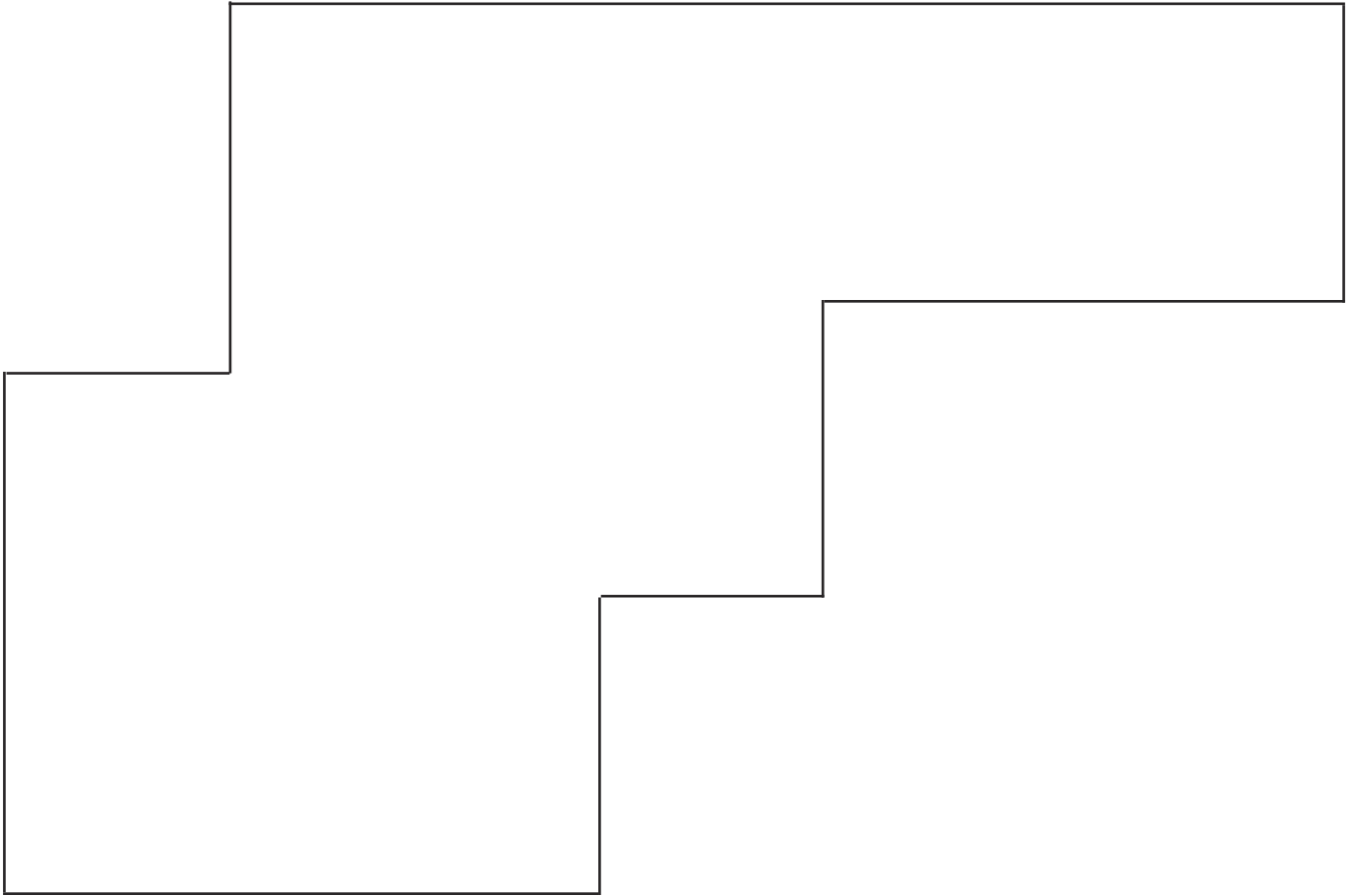

# Calculate the Perimeter of Composite Rectilinear Shapes **Answers**

★

1. 30cm
2. 26cm
3. 38cm
4. 40cm
5. 56cm
6. 34cm
7. 52cm
8. 52cm
9. 60cm

Page 2 answers will vary

★★

1. 30cm
2. 50cm
3. 54cm
4. 40cm
5. 56cm
6. 62cm
7. 58cm
8. 94cm
9. 210cm

Page 2 answers will vary

★★★

1. 36cm
2. 46cm
3. 56cm
4. 48cm
5. 60cm